

# BS&k Company

MANUFACTURERS REPRESENTATIVE

## IN MOTION FOR YOU ...

### Spring 2015

Volume 16, Issue 2



NXTEC-NXKEM: SPECIALTY PRODUCTS THAT YOU USE EVERYDAY, FOR LESS: - CLEANERS-SOLVENTS-TOOLS-SAFETY PRODUCTS-OFFICE PRODUCTS-LUBRICANTS-GROUNDS-SEWER/WASTER WATER/DRAIN-WIPES-ADHESIVES-ABSORBENTS-MRO-FIRST AID-FASTENERS-MATTING

NxTec and NxKem supplies a very wide range of products to almost any industry, small or large, office or production facilities, healthcare or workshop. Anyone who needs to clean, makes a product, provides a service or just occupies space.

Give us a try, let us know what you are buying, we'll bring you a sample to look at and try. We may even recommend a superior product that will work better for your application. Don't take our word for it, we deal with the factory technicians, lab technicians and the actual people who designed or invented these products. Their expertise is at your disposal.. Most all of our tools are lifetime guaranteed, and many have unique features. Our solvents are tested and approved by many testing labs. Our quality is second to none and our prices are very competitive. What do you have to lose by trying our products. We stand behind them.

Our products are far too numerous to list here, even the categories are too many. We are highlighting one product as a sample, but please don't think this is all we have, by far. We have "almost" a complete line on an I-Pad we carry as well as some samples. But, we can get a sample of almost anything you would like to see. Hope to talk to you soon about NxTec-NxKem.

**E-6000 Adhesive:** E-6000 is a unique adhesive formulated to meet high-performance industrial requirements. It adheres to more surfaces than virtually any other adhesive. Because it is abrasion-resistant E-6000 may be used on high-wear surfaces.

E-6000 maintains its flexible bond in cold temperatures and may be used to bond items subject to vibration. Want to see more?

(704) 365-6408

#### Inside this issue:

Lumsden's Edgewise stops tangles	2
POBCO Custom and standard products to reduce friction	3
Wiremation's new Patented Sidewinder belts reduces stretch and lets belts last longer	4
REMCO keeps you clean and sanitary	5
Superlift makes lifts in 304 SS	5
BS&k goes to work for you	5
Featured Application Sidewinder-	6

#### Special points of interest:

- Lumsden has solved the dreaded problems of "belt snagging". Let us help you extend the life of your investment!
- Wiremation's Traxx Rite sprocket driven mesh belts keeps you on the right track!
- POBCO has your material to reduce friction in your equipment
- REMCO lets you keep your clean up chores colorful and your sanitation problems seem to brighten up..
- SuperLift has the answer to stopping rusting of lifting equipment in your workplace.
- Sidewinder keeps going and going and going



PROPER DRIVING AND PROTECTING OF FLEXX FLOW BELTS ARE THE KEYS TO GETTING LONG LIFE

Lumsden's Flexx Flow belts have demonstrated for years that the tight reverse bend incorporated into our metal belts provide at least as long, and most times longer life than the other belts on the market. Since most belts are damaged long before they wear out, our Edgewise edge goes a long way to extending the life of our Flexx Flow belts. Our job at the BS&k Company is to work with you to help prevent that damage so you can get the most life you can out of your investment, and prevent interruptions to your production schedules.

Lumsden has now improved and made economical the difficult double loop edge belt manufacturing process. If your using the double edge, let us know so we can offer you a much more competitive product.

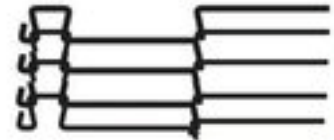

We value your business and want to be your one source for all your belting needs. Let us know how we can be of assistance to you and for extending your belt life.



**Don't forget your drive components!**

We can supply the sprockets, idle rollers, nose rollers as well as the wear strips and belt supports.

Your sprockets are by far the most important factor for a long, smooth running conveyor. Besides having the correct pitch, the teeth need to be tall enough to prevent slippage of the belt and low enough to allow the release of the belt. The wrong sprocket will wear the belt wires prematurely. Let us take a look at your application to assure you have proper sprockets.



And don't forget about what your belt rides on. Friction is a big reason your belt will fail. Friction means something is wearing on something else. And, something has to give. Don't let it be the belt for the cost of some inexpensive plastic. We have the wear strips and products



The nose rollers, in addition to tracking the belt, protect the fragile "Z" bends of the belt. By keeping the nose rollers fresh you prevent wearing out the "Z" bends and your belt. By replacing the nose rollers, with the correct size, before they wear down, you can increase the life of the belt and extend maintenance intervals Let us show you how we can save you money.



Looking for **belt supports** made out of UHMW, we can supply those as well. Just let us know what sizes and quantities. Or we would be pleased to come by and measure them for you.

We can help with all of your drive components and wear strips to reduce friction and help your belts last as long as they can.



# POBCO PLASTICS LATEST CATALOG HAS MANY NEW ITEMS TO REDUCE YOUR FRICTION AND YOUR COSTS

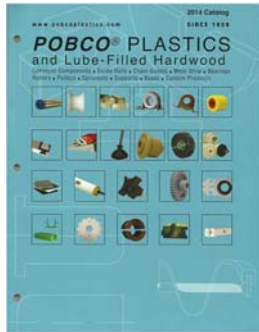

POBCO Products	POBCO Capabilities	POBCO Materials
<ul style="list-style-type: none"> <li>• Plastic Guide Rails</li> <li>• Plastic, Stainless Steel Brackets</li> <li>• Rollers (Plastic, Steel &amp; Wood)</li> <li>• Bearings (Plastic &amp; Wood)</li> <li>• Plastic Sheet Stock</li> <li>• Plastic &amp; Wood Rod Stock</li> <li>• FEP Shrink Fit Roll Covers</li> <li>• Special Rollers</li> <li>• Teflon Coated Fabric/Tapes/Belts</li> <li>• Pressure Sensitive Plastic Adhesive Wear Tape</li> </ul>	<ul style="list-style-type: none"> <li>• Extruding</li> <li>• Molding</li> <li>• CNC Machining</li> <li>• Screw Machining</li> <li>• Turning</li> <li>• Milling</li> <li>• Routing</li> <li>• Secondary Operations</li> <li>• Assembly</li> <li>• Custom Machined &amp; Extruded Profiles &amp; Shapes</li> <li>• Die Cutting/Punching</li> </ul>	<ul style="list-style-type: none"> <li>• ULTRA-D® UHMWPE (Ultra-High Molecular Weight Polyethylene)</li> <li>• Static Reduced UHMWPE</li> <li>• UV Stabilized UHMWPE</li> <li>• High Temperature UHMWPE (Fluid Lubricant-Filled UHMWPE)</li> <li>• PLUS®</li> <li>• Steel Filled UHMWPE</li> <li>• High Wear CP, Black or Green</li> <li>• Rulons® (Hi-Temp Food Grade 641, Bearing grades LR, J)</li> <li>• Low &amp; High Density Polyethylene (PE)</li> <li>• Acetal (Delrin®, Celcon®)</li> <li>• Delrin AF® (Teflon Filled Acetal)</li> <li>• Delrin® (Also Lube-Filled &amp; Oil Filled Types) (Solid Lubricant-Filled Delrin) (Fluid Lubricant-Filled High Temperature Plastic) (Lubricant-Filled Grey Nylon) (NylatronGS®)</li> <li>• DELLUBE</li> <li>• Nylon</li> <li>• NYLUBE</li> <li>• Nylon MD</li> <li>• PVC (Polyvinyl Chloride) (High Heat Plastics) PTFE® Glass Filled (Urethane: Specify Durometer Reading &amp; Color)</li> <li>• TEFLON®</li> <li>• Teflon</li> <li>• POLYURETHANE</li> <li>• POLYPROPYLENE</li> <li>• Flurosint 207® (High Heat)</li> </ul>

## POBCO® Guides and Accessories Overview

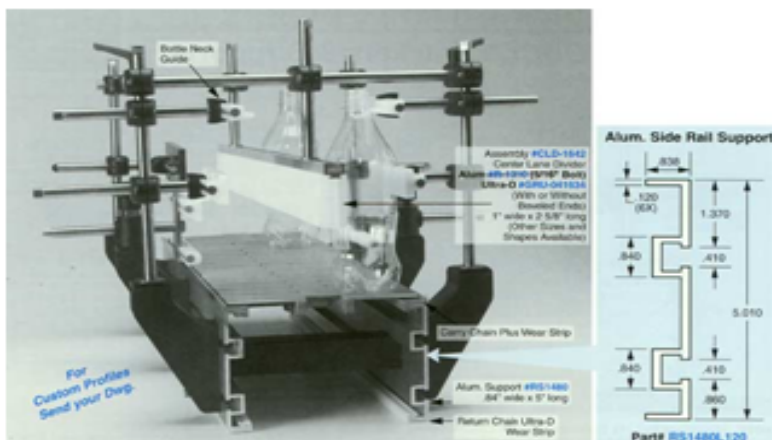



## SIDEWINDER HELPS REDUCE STRETCH AND MESH DAMAGE IN THE TOUGHEST APPLICATIONS

Lumsden introduces the new **Sidewinder Belt Family**. Balance weave belting has been around for over 100 years with minor improvements over time. There are companies that offer round wire and some that offer top flattened wire, but none have been able to conquer the challenge of shaping the **sides** of the wire, until now. Through years of R&D, Lumsden Belting has found the answer to everyone's question... How can I make my belts last longer? The answer is in the shape of the wire. With Lumsdens' patented side shaped wire design, you can extend your belt life up to **8 times** longer than your current comparable belt.

- Side shaped wire increases strength, Flattened sides reduce carry over
  - Greater open area. , Minimal stretch, Quick and easy to splice
- With Lumsdens' patented side flattened wire, the "I-beam" design gives 3 times greater structural support for your product versus the standard round wire.

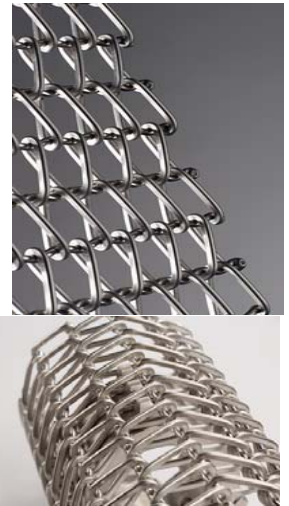

## WIREFORMATION TRAXX RITE HELPS KEEP YOU TRACKING WITHOUT EDGE DAMAGE

**Traxx Rite®** is our patented sprocket-driven line of woven wire conveyor belts. The positive driven belt ensures precision tracking of your conveyor and eliminates belt slippage in wet or oily conditions. Traxx Rite® belting is offered in a wide array of opening sizes and wire diameter. Traxx Rite® is ideal for any application that needs air flow to cool the product, openings so that any bredding or batter can easily fall through or tighter weave for smaller products to stay put for further processing. The splicing process is as simple as any balance weave belting you may already use, but much easier than other types of open surface area belting. Our Traxx Rite® line of belting is FDA approved to be used in all food processing applications.



We have designed an abbreviation of the normal 8-10 character specifications to simplify the ordering process. Please contact us if you have any questions on these.



## SPIRAL BELTS, INSTALLATION AND SERVICE

Ashworth, the inventors of the low tension spiral systems, are manufacturers of turn curve belts made from metal, hybrid metal and plastic. We can design, inspect, repair, retrofit, rebuild and install a belt for you.

Let the experts work on your spiral. You will see the difference from the beginning through the work and installation. Call today and let us show you how we can help you with the latest designs, applications and products, including our Self Stacking Belt, the ExactaStack™..

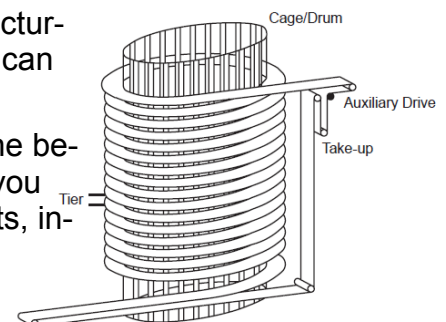





## REMCO KEEPS YOUR WORKPLACE CLEAN AND SANITARY

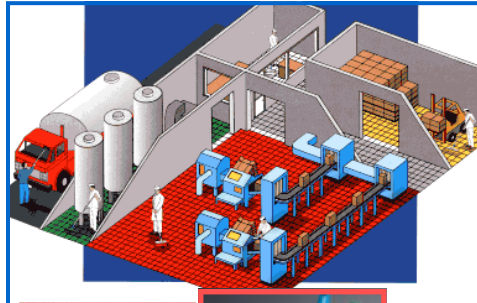

Products from **REMCO** can be color-coded to help divide the production cycle into different zones or tasks. By identifying these as different cleaning areas, the movement of contaminants around the production area can be effectively blocked.

Let **BS&k** show you how **REMCO** products can clean up your sanitation problems and let you get back to what you do best, that is, running your business.

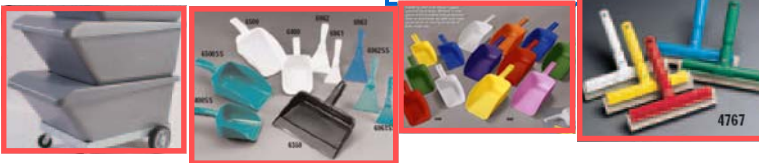

## SUPERLIFT CAN BUILD THE LIFTING DEVICES YOU NEED OUT OF 304 SS MATERIAL TO RESIST RUSTING

We have products to lift, tilt, rotate, upend, move, extend or lower your products. **Superlift Material Handling Inc.** offers one of the most complete lines in the industry from skid lifts to extra heavy duty tables. Capacities are available from 500 lbs to 100,000 lbs. We back up our quality products with first rate customer service and the best warranty in the industry. Our products are built to last in the toughest applications.



## BS&k COMPANY INTEGRATES LOCAL SERVICE WITH NATIONAL KNOWLEDGE

We have been providing local service to companies for 19 years, 11 years as the BS&k Company.

Knowledge we have gained from working with national companies has allowed us to service companies locally, the way most national companies get serviced.

With 34 years experience in sales and manufacturing environments, we know how critical it is to you to have your lines up and running, when you need them up and running. We won't let you down!

Let us work with you and provide the following:

- *Plant Surveys*
- *Complimentary Product lines*
- *Competitive Pricing*
- *On-site troubleshooting*
- *Installation Assistance*
- *Order History Analysis*
- *Stocking Plans*

Contact us today and let us show you what we can do for you.

Don't forget to ask us for your No cost / no obligation review of your production lines.

We have a CD with our literature, catalogs and other information on it. Let us send one to you.

**(800) 634-1114 (Toll free)**

**(704) 365-6408 (Local)**

**(704) 365-3578 Fax)**

[www.bsandk.com](http://www.bsandk.com)

[bob@bsandk.com](mailto:bob@bsandk.com)



[sue@bsandk.com](mailto:sue@bsandk.com)



# Featured Application

**Application:** Sidewinder Mesh Belts

**Principal:**



**Product:** Lumsden introduces the new **Sidewinder Belt Family**. Balance weave belting has been around for over 100 years with minor improvements over time. There are companies that offer round wire and some that offer top flattened wire, but none have been able to conquer the challenge of shaping the **sides** of the wire, until now. Through years of R&D, Lumsden Belting has found the answer to everyone's question... How can I make my belts last longer? The answer is in the shape of the wire. With Lumsdens' patented side shaped wire design, you can extend your belt life up to **8 times** longer than your current comparable belt.

- Side shaped wire increases strength
- Flattened sides reduce carry over
- Greater open area
- Minimal stretch

Quick and easy to splice

**Side shaped wire increases strength:**

With Lumsdens' patented side flattened wire, the "I-beam" design gives 3 times greater structural support for your product versus the standard round wire. With the added height of the wire you achieve a longer wear life, without needing heavier wire. Some tests have shown life increased by as much as **12 TIMES!**

**(800) 634-1114**

