

BS&k Company

MANUFACTURERS REPRESENTATIVE

IN MOTION FOR YOU ...

Summer 2018

Volume 19, Issue 3



CONFUSED OVER WHICH BELT IS RIGHT FOR YOUR PRODUCTION LINE? GET YOUR FREE BELT SURVEY TO CLEAR UP THE CONFUSION.

Sidewinder, Flexx Flow, Dura-hinge, Compact grid, Dura-Flex, Omni-Flex, Pac-Tite, Sani Grid, Flat Wire, Chain Edge, Exact-Stack, Baking Band, Balanced Weave, Friction Driven, Lehr Belt. Just to mention a few. Confused? Which one do I use and where? Ask each manufacturer and they will often tell you theirs is the best for every application. The BS&k Company is an independent manufacturers representative, trained by the best in the business. We will give you honest and unbiased answers with the best results and all the outcomes we have to sell is our reputations. While admittedly (just don't tell my wife because I think I have her fooled) I don't know everything and I will let you know when we can't answer something, but we do know a lot about belts and applications.

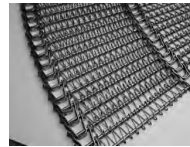
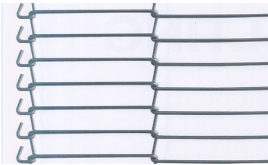
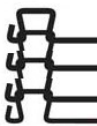
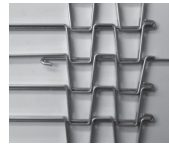
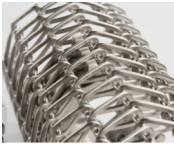

Call us today to schedule your free, no obligation, no commitment belt survey. What we do is look at your production line(s) when they are running then and look into what we thought was a problem. If necessary we can also preform a maintenance semi-maintenance team on your schedule. Let us know when and we can schedule your free survey.

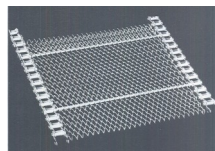
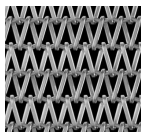

800 635-1114

704 365-6408

Inside this issue:

Our Sidewinder dramatically increases the life of your metal belting.	2
POBCO has the 2018 catalog out for all your conveyor components	3
Lumsden's Edgewise stops tangles	4
Lumsden's Flex Turn Belts	4
Wiremation Filter Belts clean your oil	5
Wiremation's Trax-Rite belts don't tear up the edges or slip out of place	5
Ashworth's Spiral belts now include Exacta Stack belts	5
Nx-Kem's in-house chemicals work Nx-Tec's MRO items save your budget	6 6
Remco's color coded cleaning tools separate cleaning chores	7
BS&k Company can serve you well	7
Featured Product—SuperLift	8

Special points of interest:

- **Lumsden** solves the dreaded problems of "belt snagging".
- **Wiremation** increases the life of your metal belts if stretch is the problem.
- **Pobco** expands PET product offering and offers the new 2018 catalog

LUMSDEN BELTING SIDEWINDER HELPS REDUCE STRETCH AND MESH DAMAGE IN THE TOUGHEST APPLICATIONS—TRY US!

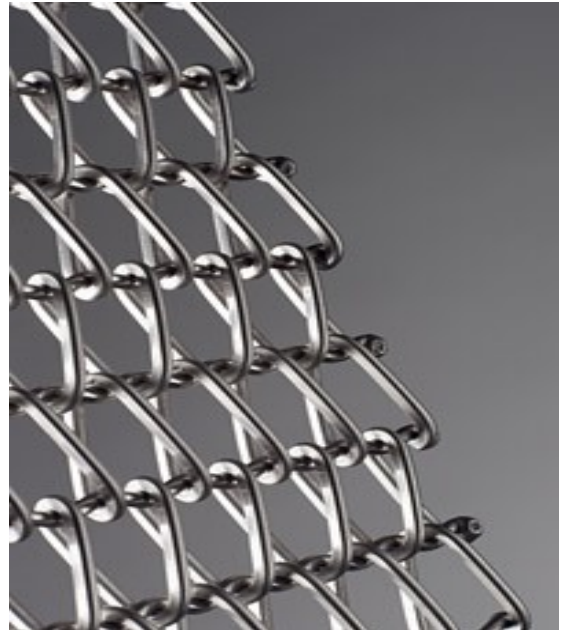

Lumsden introduces the new **Sidewinder Belt Family**.

Balance weave belting has been around for over 100 years with minor improvements over time. There are companies that offer round wire and some that offer top flattened wire, but none have been able to conquer the challenge of shaping the **sides** of the wire, until now.

Through years of R&D, Lumsden Belting has found the answer to everyone's question... How can I make my belts last longer? The answer is in the shape of the wire. With Lumsdens' patented side shaped wire design, you can extend your belt life up to **8 times** longer than your current comparable belt. And we are willing to prove it to you.

- Side shaped wire increases strength
- Flattened sides reduce carry over
- Greater open area.
- Minimal stretch
- Quick and easy to splice

With Lumsden's patented side flattened wire, the "I-beam" design gives 3 times greater structural support for your product versus the standard round wire.

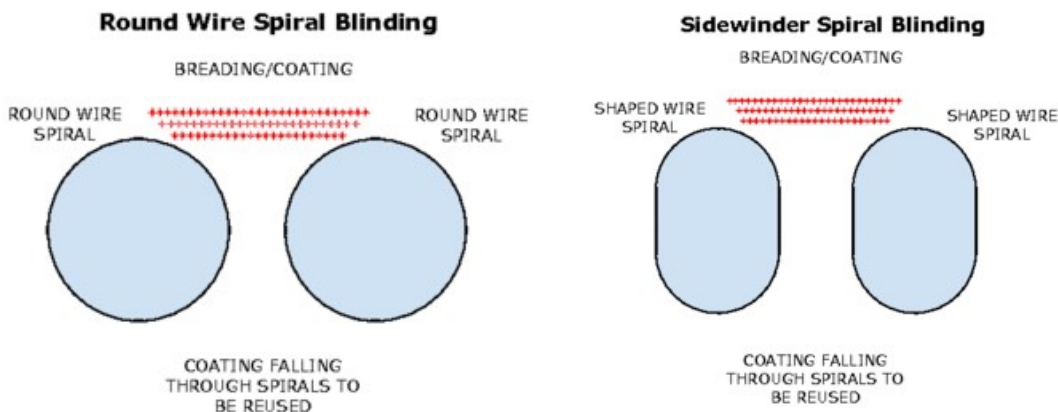



POBCO PLASTICS LATEST CATALOG HAS MANY NEW ITEMS TO REDUCE YOUR FRICTION AND YOUR COSTS

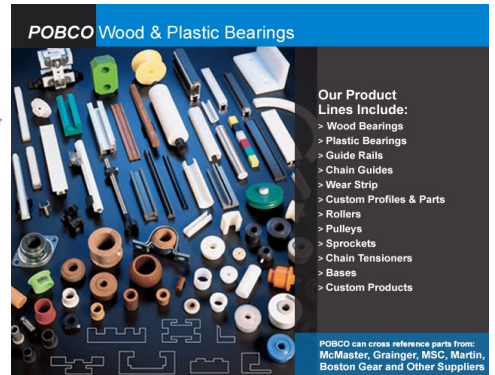
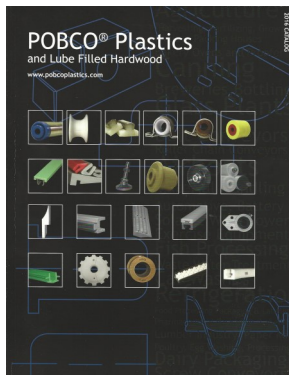

- ### POBCO Products
- Plastic Guide Rails
 - Plastic, Stainless Steel Brackets
 - Rollers (Plastic, Steel & Wood)
 - Bearings (Plastic & Wood)
 - Plastic Sheet Stock
 - Plastic & Wood Rod Stock
 - FEP Shrink Fit Roll Covers
 - Special Rollers
 - Teflon Coated Fabric/Tapes/Belts
 - Pressure Sensitive Plastic Adhesive Wear Tape

- ### POBCO Capabilities
- Extruding
 - Molding
 - CNC Machining
 - Screw Machining
 - Turning
 - Milling
 - Routing
 - Secondary Operations
 - Assembly
 - Custom Machined & Extruded Profiles & Shapes
 - Die Cutting/Punching

- ### POBCO Materials
- Blue "UXC" UHMW - ULTRA-D® UHMWPE (Ultra-High Molecular Weight Polyethylene)
 - Static Reduced UHMWPE - UV Stabilized UHMWPE
 - High Temperature UHMWPE (Fluid Lubricant-Filled UHMWPE) PLUS®
 - Steel Filled UHMWPE - High Wear CP, Black or Green
 - Rulons® (Hi-Temp Food Grade 641, Bearing grades LR, J) - Low & High Density Polyethylene (PE)
 - Acetal (Delrin®, Celcon®)
 - Delrin AF® (Teflon Filled Acetal)
 - Delrin® (Also Lube-Filled & Oil Filled Types) (Solid Lubricant-Filled Delrin) (Fluid Lubricant-Filled High Temperature Plastic) (Lubricant-Filled Grey Nylon) (NylatronGS®) - DELLUBE - Nylon - NYLUBE
 - Nylon MD = PVC (Polyvinyl Chloride) (High Heat Plastics) PTFE® Glass Filled (Urethane: Specify Durometer Reading & Color)
 - TEFLON® - Teflon - POLYURETHANE
 - POLYPROPYLENE - Flurosint 207® (High Heat)
 - ABS - Polycarbonate (Lexan®, Zelux®)
 - Polysulfone - Ultem®
 - High Pressure Laminate (Micarta®/Phenolics)® Duratlon HP (polyimide)® GF (Bearing Grade)® (PVDF)
 - Composite Bearings (High Temperature., High PV)
 - Pet (Polyester) - Torlon - Vespel/Sp-21
 - Peek - Kynar
 - Others available upon request

POBCO® Guides and Accessories Overview

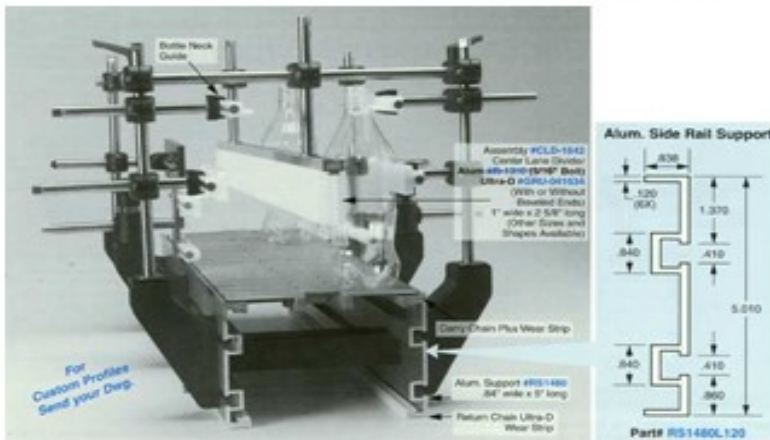



LUMSDEN'S EDGEWISE BELT HAS DRASTICALLY REDUCED BELT WASTE DUE TO TANGLING



Lumsden's **Edgewise** edge has proven to many customers that this design prevents tangling and catching of the wires both on and off the machine. They come off the rolls un-tangled, they don't catch on adjoining belts, and there are no ends to bend open and break.

Less downtime, less scrap and with the buffed edge, less cut hands. A real winner in all cases.

With the **Edgewise** edge, wires do not have to be opened and then closed again to splice belt. This prevents the ends from breaking off, and having to re-splice the belt, like other belts do.



Don't forget your drive components!

We can supply the sprockets, idle rollers, nose rollers as well as the wear strips and belt supports. The nose rollers, in addition to tracking, protect the "Z" bends of the belt. By replacing them before they wear down, you can increase the life of the belt and extend maintenance intervals Let us show you how we can save you money. http://www.bsandk.com/?page_id=943



LUMSDEN FLEX TURN BELTS, THE NEXT GENERATION IS HERE .

Lumsden has the new and improved Flex Turn Belt. This belt is made to precise tolerances and without any splice clips that can harbor bacteria.



Lumsden Turn Belt - Look, no tubes!



Edgewise "Snag-free" edges

Our longer belt edge greatly reduces tangling during installation and improves operator safety by making it virtually impossible to snag.



Typical Competition Belt Edge



Lumsden Belt Edge

Our belt is a "drop on" belt that requires no modifications to your existing conveyor. We'll be happy to show you the difference.

http://www.bsandk.com/?page_id=2514

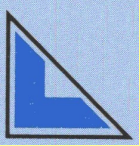

WIREMATION CLEANS UP YOUR OILY PROBLEMS WITH IT'S FILTER BELT

Filter Belts Any plant that is frying is a likely Filter Belt customer. Filter Belts are most commonly used in the Stein SF Series Continuous Force Flow Filter, which is, by far, the most common system used in the industry. These belts are used to filter the oil used in the fryer, extending the life of the frying oil and minimizing the formation of fatty acids. Filter belts can remove particles as small as 80 micron or 60 micron. After the particles are removed from the oil, they are removed from the belt by a scraper for reclamation or recycling.

In addition to the 316 SS Reverse Double Dutch weave mesh material and the low profile alligator lace, contact us to tell you the other features why our filters do a better job, and last longer.

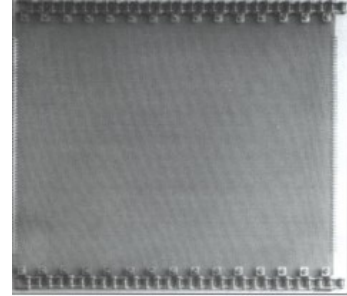

WIREMATION TRAXX RITE HELPS KEEP YOU TRACKING WITHOUT EDGE DAMAGE

Traxx Rite® is our patented sprocket-driven line of woven wire conveyor belts. The positive driven belt ensures precision tracking of your conveyor and eliminates belt slippage in wet or oily conditions. Traxx Rite® belting is offered in a wide array of opening sizes and wire diameter. Traxx Rite® is ideal for any application that needs air flow to cool the product, openings so that any breadings or batter can easily fall through or tighter weave for smaller products to stay put for further processing. The splicing process is as simple as any balance weave belting you may already use, but much easier than other types of open surface area belting. Our Traxx Rite® line of belting is FDA approved to be used in all food processing applications.



We have designed an abbreviation of the normal 8-10 character specifications to simplify the ordering process. Please contact us if you have any questions on these.



SPIRAL BELTS, INSTALLATION AND SERVICE

Ashworth, the inventors of the low tension spiral systems, are manufacturers of turn curve belts made from metal, hybrid metal and plastic. We can design, inspect, repair, retrofit, rebuild and install a belt for you.

Let the experts work on your spiral. You will see the difference from the beginning through the work and installation. Call today and let us show you how we can help you with the latest designs, applications and products, including our Self Stacking Belt, the ExactaStack™..

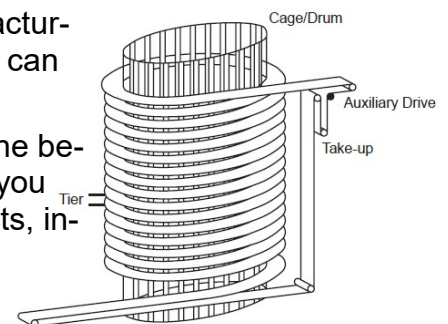



NX-KEM KEEPS YOUR MRO BUDGET IN CHECK WITH QUALITY CHEMICALS AT REASONABLE PRICES

NX-Kem distributes our own branded formulations on the national level. Whether you need industrial or commercial applications, our high-quality formulations can tackle the job, no matter how small or large it may be. We are ready to help you find the perfect formulation for all of your repair, operational and cleaning needs. Here are just a few of the broad categories our more than 500 branded formulations cover:

Adhesives—Carpet Care—Cleaners—Coatings—Deodorants—Disinfectants—Floor Care—Grounds—Lubricants—Patching—Pest Control—Sewer & Drain—Skin Care—Solvents Water Treatment—Water Products—Wipes—Equipment—Earth-friendly—Special and Custom

Let us help you, at affordable prices. Call us today (704) 365-6408

Whatever your specialized formulation needs might be, NXKEM has the solution. Let us



NX-TEC PROVIDES TOOLS, SUPPLIES AND EVERYDAY ITEMS YOU USE AT PRICES YOU CAN AFFORD

As a national distributor of maintenance, repair and operational products, NXTEC is ideally poised to meet all of your needs across a broad range of business sector. We offer over one million items from facilities maintenance supplies, janitorial supplies, fasteners and hardware, to first aid and safety supplies. We are here to help you source the exact supplies you need. Here are a few of the item categories we cover:

* Facilities Maintenance Supplies—*Cleaning & Janitorial Supplies—*Office & Business Supplies—*Safety Supplies—*Fasteners & Hardware Supplies—*First Aid Supplies

If you're looking for the ideal operational solutions for your business, we can provide for your needs. Give us a call today to let us know how we can assist you. (704) 365-6408

http://www.bsandk.com/?page_id=2215



WE PROVIDE SOLUTIONS TO YOUR AUTOMATION CHALLENGES

Wrabacon has designed and manufactured automated conveyor systems for products of varied shapes, sizes and weights, with each design tailored to fit into the curves, bends, raising or lowering of existing production lines. These systems can be stand-alone units or integrated to respond and operate with a customer's in-use equipment.

Product input can be singular or multiple, and the automated conveyor systems are programmed to carry the products at speeds compatible with upstream or downstream components. These conveyors reduce or eliminate physical handling of product, which in turns generates a controlled product flow through the system that can be increased or decreased as the demands of the system dictate. We are experts in controlling product orientation, and creating controls that determine product movement. Each System is designed to meet the specific requirements of the customer and product. Various types of conveyors are available based on customer requirements. Mild steel, painted steel and stainless conveyors are available.

Let us design some equipment for you. http://www.bsandk.com/?page_id=123



REMCO KEEPS YOUR WORKPLACE CLEAN AND SANITARY

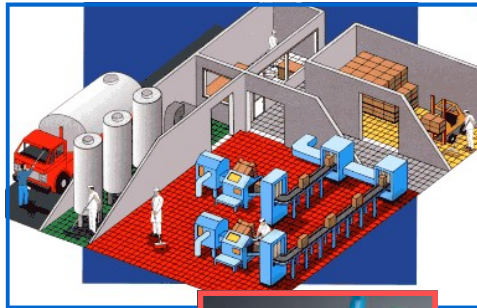

Products from **REMCO** can be color-coded to help divide the production cycle into different zones or tasks. By identifying these as different cleaning areas, the movement of contaminants around the production area can be effectively blocked.

Let **BS&k** show you how **REMCO** products can clean up your sanitation problems and let you get back to what you do best, that is, running your business.

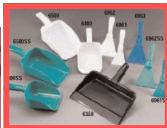

BS&k COMPANY INTEGRATES LOCAL SERVICE WITH NATIONAL KNOWLEDGE

The BS&k company has been providing local service to companies for 18 years.

Knowledge we have gained from working with national companies has allowed us to service companies locally, the way most national companies get serviced.

With 40 years experience in sales and manufacturing environments, we know how critical it is to you to have your lines up and running, when you need them up and running. We won't let you down!

Let us work with you and pro-

vide the following:

- *Plant Surveys*
- *Complimentary Product lines*
- *Competitive Pricing*
- *On-site troubleshooting*
- *Installation Assistance*
- *Order History Analysis*
- *Stocking Plans*

Contact us today and let us show you what we can do for you.

Don't forget to ask us for your No cost / no obligation review

of your production lines.

We have a CD with our literature, catalogs and other information on it. Let us send one to you.

(800) 634-1114 (Toll free)
 (704) 365-6408 (Local)
 (704) 365-3578 (Fax)

www.bsandk.com

bob@bsandk.com



sue@bsandk.com

Featured Application

Application: Stainless Steel Lifting Devices

Principal: SuperLift



SuperLift is A North American Supplier of Industrial Lifting & Handling Equipment including Scissor Lifts, Tilters, Up-enders, Turntables, Dock Lifts, Specialized Electric Lift Trucks. They also specialize in the custom manufacture of any lift device you can come up with. All Capacities are from 500 to 200,000 lbs

Product: Stainless Steel Scissor Lifts.

- Capacities from 250 lbs to 20,000 lbs
 - Standard lifts, ground level, lift and tilts, double lifts, low profile, heavy duty all available
 - 304 and 316 stainless steel polished #4 or mirror finishes
 - Stainless steel cylinders or ball screw units for precision applications
 - Lift heights to 120"
 - Custom lifts and powered drive also Available.
 - Powered by air, hydraulic or electric ball screw



(800) 634-1114

BS&k Company
 MANUFACTURERS REPRESENTATIVE 